

## 85 & 95 W Programmable Constant Current Class 2 LED Driver with 0-10 V Dimming, Dim-to-Off and Optional Auxiliary Output

Input Voltage (Vac)	Max. Output Power	Output Voltage (Vdc)	Output Current (mA)	Efficiency	Max. Case Temperature	THD	Power Factor	Dimming Method	Dimming Range	Startup Time
120 - 277	95 W	10 - 55	700 - 2750	up to 92% typical	Life : 85°C UL : 90°C	< 20% @ max load	> 0.9	0 - 10 V with Dim-to-Off	1 - 100%	300 ms typical

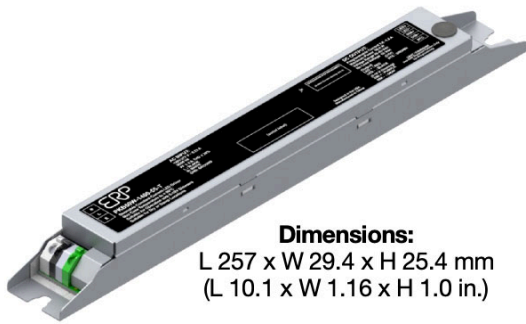

### FEATURES

- Up to 92% efficiency typical
- Current tolerance of  $\pm 2\%$  typical
- Meets IEEE 1789-2015 “no impact” recommended practices for flicker
- Programmable 0-10 V from 100% to “Dim-to-Off” complies with ANSI C137.1
- Numerous programmable dimming profiles
- Programmable auxiliary (-TXZ) output from 9.5 V to 24 V
- UL Listed Class P, Class 2 power supply
- Lifetime Warranty: 50,000 hours / 5 years @  $T_c \leq 85^\circ\text{C}$
- Extended Lifetime: 100,000 hours at  $T_c \leq 75^\circ\text{C}$
- Complies with ENERGY STAR®, DLC, and CA Title 24
- Surge protection:
  - IEC61000-4-5: 6 kV line to line/6 kV line to earth
  - ANSI/IEEE c62.41.1-2002 & c62.41.2-2002 category A 2.5 kV ring wave

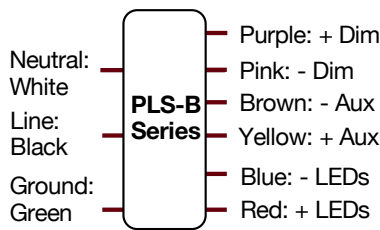

Wiring Diagram

### PROGRAMMING

- Audio jack and cradle programming
- Current: see page 2 for current range
- 0-10 V dimming profiles: Linear, Non-linear, Logarithmic
- Data log read: SKU, S/N, lot code, hours of operation, FW rev., power cycles

### APPLICATIONS

- Commercial Lighting
- Architectural Lighting
- Office Lighting
- Compatible with Lutron Athena Wireless Node

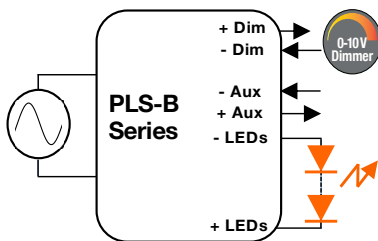

Application Diagram

### CERTIFICATIONS/STANDARDS



CA Title 24



## 85 & 95 W Programmable Constant Current Class 2 LED Driver with 0-10 V Dimming, Dim-to-Off and Optional Auxiliary Output

### 1 - ORDERING INFORMATION

Part Number	Input Voltage (Vac)	Max Output Power (W)	Iout (mA) <sup>(1)</sup>	Default Programmed Current (mA)	Vout Min. (Vdc)	Vout Nom. (Vdc)	Vout Max. (Vdc) <sup>(2)</sup>	Open Loop (No Load) Voltage (Vdc)	Notes
<b>66 to 85W</b>									
PLS-B85W-23-55-TZ	120 - 277	85	700 to 2300	1400	10	49.5	55	60	
PLS-B85W-23-55-TXZ	120 - 277	85	700 to 2300	1400	10	49.5	55	60	Auxiliary Output
<b>86 to 95W</b>									
PLS-B95W-27-55-TZ	120 - 277	95	900 to 2750	1700	10	49.5	55	60	
PLS-B95W-27-55-TXZ	120 - 277	95	900 to 2750	1700	10	49.5	55	60	Auxiliary Output

#### NOTES:

- (1) The ERP LED Driver Configuration Tool (ERP GUI) allows programming of the output current to values below the minimum limits specified in the table above. However, when the programmed output current is set below these minimum thresholds, the LED driver's Total Harmonic Distortion (THD) and Power Factor (PF) may not meet the values defined in the INPUT SPECIFICATION section of this datasheet. For proper operation, please also refer to the OPERATING ENVELOPE for each part number, which defines the permissible ranges of output current and output voltage where THD and PF compliance is maintained.
- (2) The forward voltage (Vf) of the LED load should not exceed Vout Max. of the driver under worst case field operating conditions which are the Vf max. of the LED load under lowest temperature and highest forward current conditions. As a general design guideline, the nominal LED load Vf measured at the operating current and at room temperature should be  $\leq$  Vout Nom. of the driver.

### 2 - ACCESSORIES

#### NOTES:

- Please order the programming cable using part number PROG-JACK-USB.

#### Programming Cable



Figure 1

**85 & 95 W Programmable Constant Current Class 2 LED Driver with 0-10 V Dimming, Dim-to-Off and Optional Auxiliary Output**

**3 – OPERATING ENVELOPES**

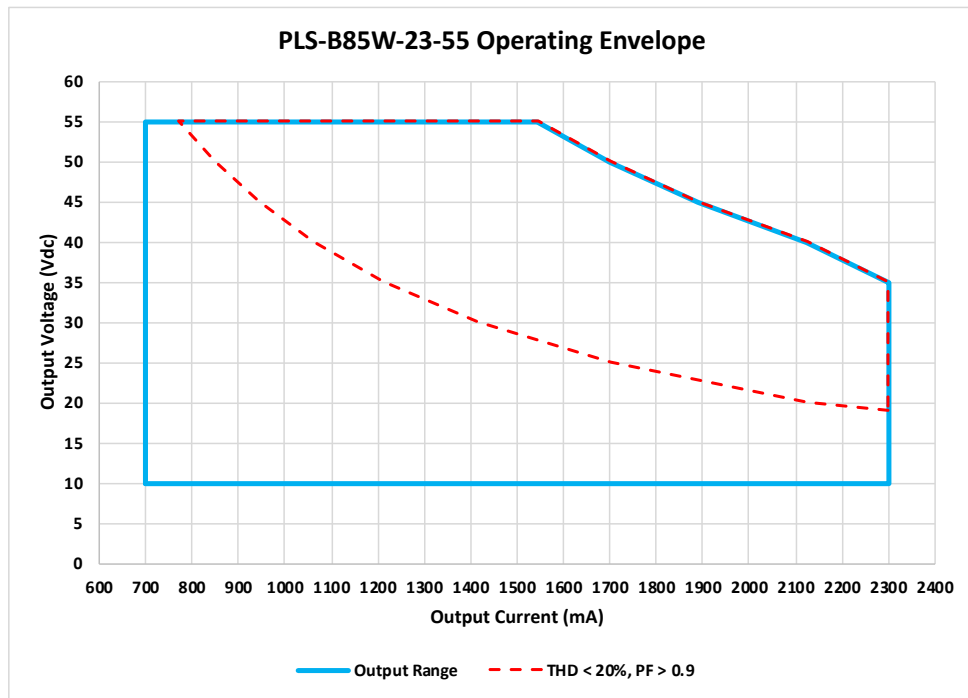

**Figure 2**

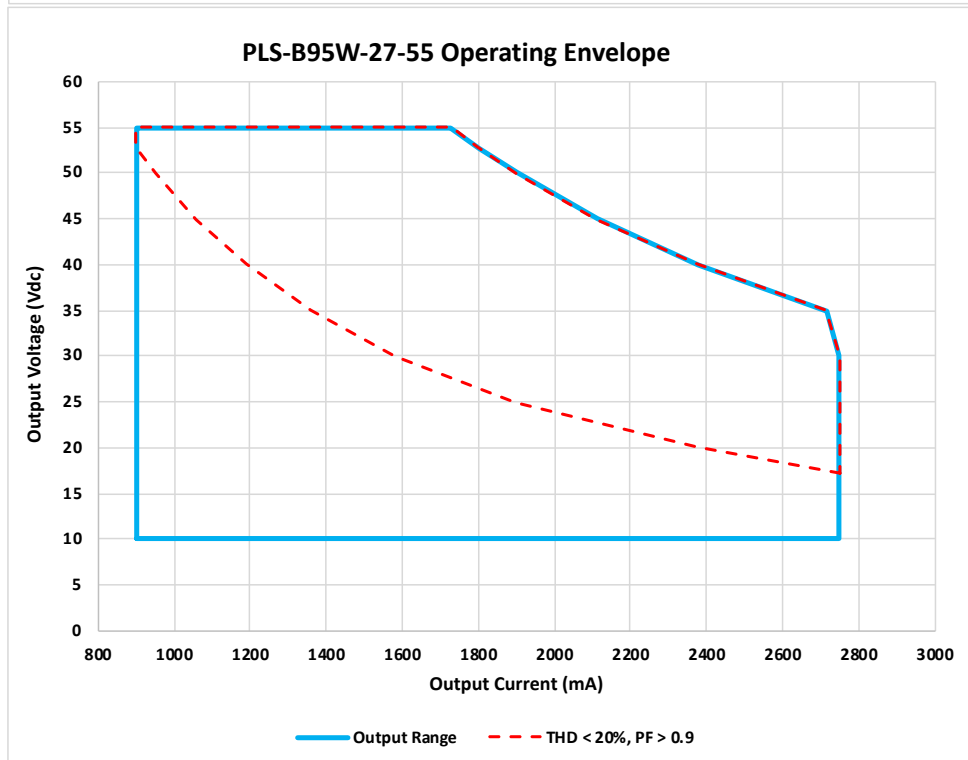

**Figure 3**

**NOTE:** Meeting DLC Requirements require 50% Loading

## 85 & 95 W Programmable Constant Current Class 2 LED Driver with 0-10 V Dimming, Dim-to-Off and Optional Auxiliary Output

### ■ 4 - INPUT SPECIFICATION (@25°C ambient temperature)

	Units	Minimum	Typical	Maximum	Notes
<b>Input Voltage Range (Vin)</b>	Vac	108	120 - 277	305	<ul style="list-style-type: none"> <li>•The rated output current for each model is achieved at <math>V_{in} \geq 108</math> Vac, &amp; at <math>V_{in} \geq 249</math> Vac.</li> <li>•At nominal load</li> </ul>
<b>Input Frequency Range</b>	Hz	47	50/60	63	-
<b>Input Current (Iin)</b>	A	-	-	0.9 A @ 120 Vac 0.45 A @ 277 Vac	-
<b>Power Factor (PF)</b>		0.9	> 0.9		<ul style="list-style-type: none"> <li>•At nominal input voltage (120 &amp; 277 Vac) and no dimmer</li> <li>•From 100% to 60% of output power</li> </ul>
<b>Inrush Current</b>	A	Meets NEMA- 410 Requirements			<ul style="list-style-type: none"> <li>•At any point on the sine wave and 25°C</li> <li>Meets NEMA-410 requirements</li> </ul>
<b>Leakage Current</b>	mA	-	-	0.4 mA @ 120 Vac 0.75 mA @ 277 Vac	Measured per IEC60950-1
<b>Total Harmonics Distortion (THD)</b>		-	-	20%	<ul style="list-style-type: none"> <li>•At nominal input voltage (120 &amp; 277 Vac)</li> <li>•From 100% to 50% of output power</li> <li>•Complies with DLC (Design Light Consortium) technical requirements</li> </ul>
<b>Efficiency</b>	%	-	up to 92%	-	Measured with nominal input voltage, a full sinusoidal wave form and without dimmer attached.
<b>Standby Power</b>	W			0.5 1	<ul style="list-style-type: none"> <li>•At 120 Vac</li> <li>•At 277 Vac</li> </ul>
<b>Isolation</b>	The AC input to the main DC output is isolated.				

## 85 & 95 W Programmable Constant Current Class 2 LED Driver with 0-10 V Dimming, Dim-to-Off and Optional Auxiliary Output

### ■ 5 - MAIN OUTPUT SPECIFICATION (@25°C ambient temperature)

	Units	Minimum	Typical	Maximum	Notes
<b>Output Voltage (Vout)</b>	Vdc	-	-	-	•See ordering information for details
<b>Output Current (Iout)</b>	mA	-	-	-	•See ordering information for details •Output voltage and current combination cannot exceed max power output. See page 3 for operating window •The rated output current for each model is achieved at $V_{in} \geq 108$ Vac & $V_{in} \geq 249$ Vac.
<b>Output Current Regulation</b>	%	-3	$\pm 2$	3	•At nominal AC line voltage (120 & 277 Vac) •Includes load and current set point variations
<b>Output Current Overshoot</b>	%	-	-	20	The driver does not operate outside of the regulation requirements for more than 500 ms during power on with nominal LED load and without dimmer.
<b>Ripple Current</b>	$\leq 10\%$ of rated output current for each model				•Measured at nominal LED voltage and nominal input voltage without dimming •Calculated in accordance with the IES Lighting Handbook, 9th edition •Compliant with IEEE1789-2015. Meets "No Impact" levels
<b>Dimming Range</b>	%	1	-	100	•The dimming range is dependent on each specific dimmer. It may not be able to achieve 1% dimming with some dimmers. •When testing, if light is measured, dimming range is based on light output. If no light is measured, dimming range is based on percentage of output current. •Dimming performance is optimal when the driver is operated at its nominal output voltage matching the LED nominal Vf (forward voltage). Dimming performance may vary when the driver is operated near its minimum output voltage.
<b>Start-up Time</b>	ms	-	300	500	•Without any dimmer attached, and at nominal input voltages and nominal load •Synchronized start-up of 100 ms when multiple drivers on same circuit •Measured from application of AC line voltage to continuous light output •Complies with ENERGY STAR® luminaire specification and CA Title 24
<b>Isolation</b>	The main DC output is certified and tested per UL8750 Class 2 or LED Class 2.				

### ■ 6 - AUXILIARY OUTPUT SPECIFICATION “-TXZ” MODELS ONLY (@25°C ambient temperature)

	Units	Minimum	Typical	Maximum	Notes
<b>Auxiliary Output Voltage</b>	Vdc	9.5	12	24	•Default value is 12 V • $\pm 20\%$ voltage regulation •Configurable through programming in 0.5 V increments
<b>Auxiliary Output Power</b>	W	-	-	1.2	-

## 85 & 95 W Programmable Constant Current Class 2 LED Driver with 0-10 V Dimming, Dim-to-Off and Optional Auxiliary Output

### 7 - DEFAULT 0-10 V DIMMING PROFILE (@25°C ambient temperature)

Using the ERP LED Driver Configuration Tool (ERP GUI), users can select from several 0–10V dimming profiles, including a logarithmic profile, an ANSI C137.1-compliant profile, and non-linear profiles with either 1% or 10% minimum dimming, each available with or without dim-to-off.

Dim-to-off can be enabled or disabled independently, and a fully user-defined dimming profile can also be created, allowing precise programming of every point along the dimming curve.

By default, the LED Driver is configured with a pre-loaded non-linear dimming profile, providing a minimum dimming level of 1% and no dim-to-off functionality, as illustrated in Figure 4.

	Units	Minimum	Typical	Maximum	Notes
<b>Default Dimming Profile (see figure 4)</b>		100% of output current between 10 V and 8 V, Linear between 8 V and 1 V, 1% of output current below 1 V.			
<b>Dimming Range</b>	%	1		100	When testing, if light is measured, dimming range is based on light output. If no light is measured, dimming range is based on percentage of output current.
<b>High Level Voltage - A</b>	V		8.0		
<b>Low Level Voltage - B</b>	V		1.0		
<b>Current Supplied by the +Dim Signal Pin</b>	mA			0.5	
<b>Dimming Voltage Sensing Tolerance</b>	mV			100	The tolerance of the difference between the 0-10 V signal supplied by the dimmer and sensed by the driver.
<b>Output Current Tolerance While Being Dimmed</b>	%		±8		In the linear region of the dimming curve (between points A and B in Figure 4).
<b>Output Current Tolerance at Minimum Dimming</b>	%	0.5		2	The tolerance of the output current at minimum dimming varies from 0.5% of 2% of the programmed output current of each driver.
<b>Isolation</b>	The 0-10 V circuit is isolated from the AC input and meets UL8750 supplement SF requirements.				

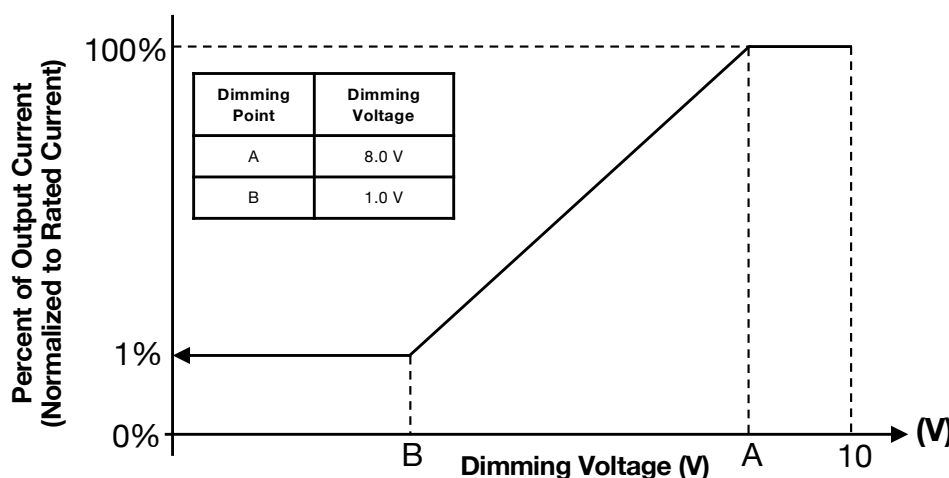

Figure 4

## 85 & 95 W Programmable Constant Current Class 2 LED Driver with 0-10 V Dimming, Dim-to-Off and Optional Auxiliary Output

### 8 - ENVIRONMENTAL CONDITIONS

	Units	Minimum	Typical	Maximum	Notes
<b>Operating Ambient Temperature (Ta)</b>	°C	-20	-	50	50°C is the non-derated temperature (Refer to section 12 'Output power de-rating at elevated temperatures'.)
<b>Maximum Case Temperature (Tc)</b>	°C	-	-	+90	Case temperature measured at the hot spot •tc (see label on page 17)
<b>Storage Temperature</b>	°C	-40	-	+85	-
<b>Humidity</b>	%	5	-	95	Non-condensing
<b>Cooling</b>	Convection cooled				-
<b>Acoustic Noise</b>	dBA	-	-	24	Measured at a distance of 1 foot, without dimmer
<b>Mechanical Shock Protection</b>	per EN60068-2-27				-
<b>Vibration Protection</b>	per EN60068-2-6 & EN60068-2-64				-
<b>MTBF</b>	> 200,000 hours when operated at nominal input and output conditions, and at Tc ≤ 85°C				
<b>Lifetime</b>	50,000 hours at Tc ≤ 85°C maximum case hot spot temperature (see hot spot •tc on label on page 17) 100,000 hours possible at Tc ≤ 75°C . See table on Page 12.				
<b>Warranty</b>	The warranty period shall not exceed five (5) years. The user is responsible for implementing appropriate thermal management practices to ensure adequate thermal conductivity between the driver and the heat sink. Failure to provide proper thermal management may result in reduced product performance and will void the warranty, i.e. The use of <u>double-sided</u> tape or similar mounting methods is expressly prohibited and shall void any applicable warranty.				

### 9 - EMC COMPLIANCE, SAFETY, AND ENVIRONMENTAL APPROVALS

EMC Compliance					
<b>Conducted and Radiated EMI</b>	•Compliant with FCC CFR Title 47 Part 15 Class A at 120 & 277 Vac				
<b>Voltage Fluctuations &amp; Flicker</b>	IEC61000-3-3		-		
<b>Immunity Compliance</b>	<b>ESD (Electrostatic Discharge)</b>	IEC61000-4-2	6 kV contact discharge, 8 kV air discharge, level 3		
	<b>RF Electromagnetic Field Susceptibility</b>	IEC61000-4-3	3 V/m, 80 - 1000 MHz, 80% modulated at a distance of 3 meters		
	<b>Electrical Fast Transient</b>	IEC61000-4-4	± 2 kV on AC power port for 1 minute, ±1 kV on signal/control lines		
	<b>Surge</b>	IEC61000-4-5	± 6 kV line to line (differential mode) /± 6 kV line to common mode ground		
			ANSI/IEEE c62.41.1-2002 & c62.41.2-2002 category A, 2.5 kV ring wave		
	<b>Conducted RF Disturbances</b>	IEC61000-4-6	3V, 0.15-80 MHz, 80% modulated		
	<b>Voltage Dips</b>	IEC61000-4-11	>95% dip, 0.5 period; 30% dip, 25 periods; 95% reduction, 250 periods		
Safety & Environmental Approvals					
<b>UL</b>	UL8750 listed Class 2, supplement SF				
<b>cUL</b>	CAN/CSA C22.2 No. 250.13-14 LED equipment for lighting applications				
Safety					
	Units	Minimum	Typical	Maximum	Notes
<b>Hi Pot (High Potential) or Dielectric voltage-withstand</b>	Vdc	2200	-	-	•Tested at the RMS voltage equivalent of 1555 Vac

## 85 & 95 W Programmable Constant Current Class 2 LED Driver with 0-10 V Dimming, Dim-to-Off and Optional Auxiliary Output

### ■ 10 - DIMMING FEATURES

#### **Synchronized Start-up**

The driver incorporates a synchronized start-up feature. When wired into the same dimmer, multiple LED drivers will dim to the same level and turn on within 100 ms of each other.

#### **Fully Programmable 0-10V Dimming Profile**

Users can configure multiple 0–10V dimming profiles via the ERP LED Driver Configuration Tool (ERP GUI), including logarithmic, ANSI C137.1-compliant, and non-linear options with 1% or 10% minimum dimming, with or without dim-to-off.

Dim-to-off can be enabled or disabled independently, and a fully user-defined dimming profile can also be created, allowing precise programming of every point along the dimming curve.

### ■ 11 - PROTECTION FEATURES

#### **Input Over Current Protection**

The driver incorporates a primary AC line fuse for input over current protection to prevent damage to the LED driver and meet product safety requirements as outlined in Section 6.

#### **Short Circuit and Over Current Protection**

The LED drivers protected against short-circuit such that a short from any output to return shall not result in a fire hazard or shock hazard. The driver operates in a hiccup mode if a short circuit or over current fault occurs. Removal of the fault will return the driver to within normal operation. The driver shall recover, with no damage.

#### **Internal Over temperature Protection**

The driver is equipped with an internal temperature sensor on the primary power train. Failure to stay within the convection power rating will result in the power supply reducing the available current (fold back) below the programmed amount. The main output current will be restored to the programmed value when the temperature of the built-in temperature sensor cools adequately.

#### **Output Open Load Protection**

When the LED load is removed, the output voltage of the driver is typically limited to 60 V, to meet Class 2 standard.

#### **0-10V Dimming Circuit Protection**

The 0–10V dimming circuit incorporates integral protection against inadvertent mis-wiring. Under such conditions, including the accidental application of AC line voltage to the dimming leads at any nominal input voltage, the circuit is designed to prevent damage to the product

### ■ 12 - OUTPUT POWER DE-RATING AT ELEVATED TEMPERATURES

The driver can be operated with cooling air temperatures above 50°C by linearly de-rating the total maximum output power (or current) by 2.5%/°C until internal over temperature protection activates.

## 85 & 95 W Programmable Constant Current Class 2 LED Driver with 0-10 V Dimming, Dim-to-Off and Optional Auxiliary Output

### 13 - 0-10 V DIMMING

The driver operates only with 0-10 V dimmers that sink current. They are not designed to operate with 0-10 V control systems that source current, as used in theatrical/entertainment systems. The 0-10 V sinking current control method is adopted by the International Electrotechnical Commission (IEC) as part of its IEC Standard 60929 Annex E.

The method to dim the output current of the driver is done via the + /- Dim Signal pins. The + Dim/- Dim Signal pins respond to a 0 to 10 V signal, delivering 1% to 100% of the output current based on rated current for each model. A pull-up resistor is included internal to the driver. If the + Dim input is > 10 V or open circuited, the output current is programmed to 100% of the rated current.

The maximum source current (flowing from the driver to the 0-10 V dimmer) supplied by the + Dim Signal pin is  $\leq 0.5$  mA. The tolerance of the output current while being dimmed shall be  $\pm 8\%$  typical until down to 1 V.

Using the ERP LED Driver Configuration Tool (ERP GUI), users can select from several 0–10V dimming profiles, including a logarithmic profile, an ANSI C137.1-compliant profile, and non-linear profiles with either 1% or 10% minimum dimming, each available with or without dim-to-off.

Dim-to-off can be enabled or disabled independently, and a fully user-defined dimming profile can also be created, allowing precise programming of every point (A, B, C, D) along the dimming curve.

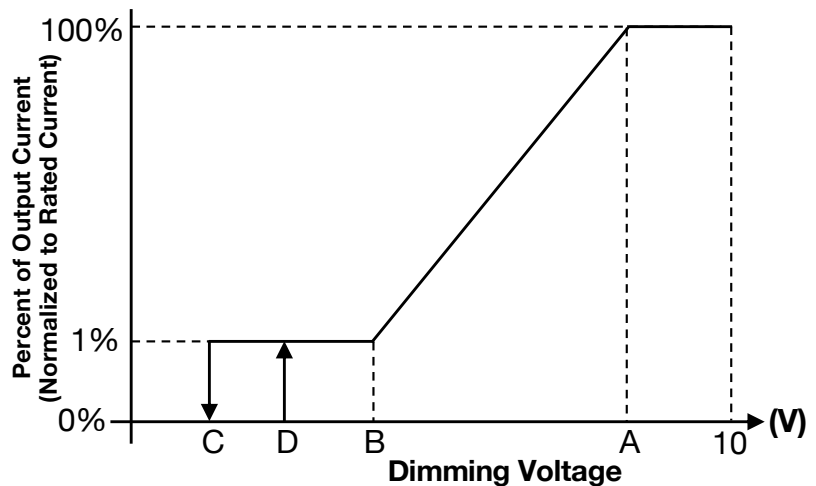

**Figure 5**

	Units	Minimum	Typical	Maximum	Tolerance	Notes
<b>Dimming Range</b>	%	1		100		When testing, if light is measured, dimming range is based on light output. If no light is measured, dimming range is based on percentage of output current.
<b>High Level Voltage - A (Recommended Range)</b>	V	7.0		9.0	$\pm 100$ mV	Point A can actually be programmed to any value but it should never go below Point B.
<b>Low Level Voltage - B (Recommended Range)</b>	V	1.0		2.0	$\pm 100$ mV	Point B can actually be programmed to any value but it should never go beyond Point A.
<b>Dim to Off Range - C (Recommended Range)</b>	V	0.5		1.0	$\pm 100$ mV	
<b>Dim to On Range - D (Recommended Range)</b>	V	0.7		1.0	$\pm 100$ mV	
<b>Current Supplied by the +Dim Signal Pin</b>	mA			0.5		
<b>Dimming Voltage Sensing Tolerance</b>	mV				100	The tolerance of the difference between the 0-10 V signal supplied by the dimmer and sensed by the driver.
<b>Output Current Tolerance While Being Dimmed</b>	%				$\pm 8$	In the linear region of the dimming curve (between points A and B in Figure 5).
<b>Output Current Tolerance at Minimum Dimming</b>	%	0.5		2		The tolerance of the output current at minimum dimming varies from 0.5% to 2% of the programmed output current of each driver.

## 85 & 95 W Programmable Constant Current Class 2 LED Driver with 0-10 V Dimming, Dim-to-Off and Optional Auxiliary Output

### 14 - COMPATIBLE 0-10 V DIMMERS

Lutron	Leviton
Nova series: NFTV	IllumaTech series: IP710-DL
Diva Series: DVTV	

**NOTE:** Dimming compatibility charts are available for each model on the PLS-B series page at: [erp-power.com](http://erp-power.com).

### 15 - CONNECTION AND COMPATIBILITY WITH EXTERNAL SENSORS

The LED Driver is compatible with the Lutron Athena wireless node when programmed as an ANSI C137.1 0-10 V driver.



Athena RF Wireless Node

#### Athena Wireless Node Wiring Guide

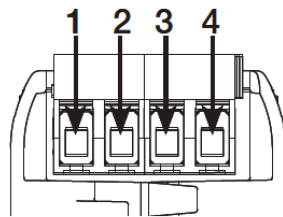

Athena Connector Description	ERP LED Driver Wiring
1: AUX+	+Aux (Yellow)
2: AUX-	-Aux (Brown)
3: SIG+	+Dim (purple)
4: SIG-/DGND	-Dim (pink)

#### Connecting an Athena Wireless Sensor Node to an ERP LED Driver with Auxiliary Output (e.g. PLH, PRH, PLS series):

- Connect the AUX+ of Athena to the +Aux (yellow) wire of the ERP LED Driver
- Connect the AUX- of Athena to the -Aux (brown) wire of the ERP LED Driver
- Connect the SIG+ of Athena to the +Dim (purple) of the ERP LED Driver
- Connect the SIG- of Athena to the -Dim (pink) of the ERP LED Driver

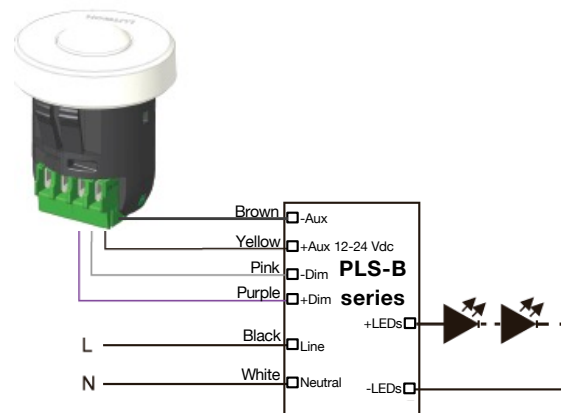

Figure 6

## 85 & 95 W Programmable Constant Current Class 2 LED Driver with 0-10 V Dimming, Dim-to-Off and Optional Auxiliary Output

### ■ 16 - PROGRAMMING

The LED Driver can be programmed by inserting the audio jack of the cable shown in figure 7 into the driver and by plugging the USB other end of the cable into a computer. **The driver should not be powered on during the programming process.**

When ordering the LED driver, please ensure that a programming cable is also included. The programming cable can be ordered under part number **PROG-JACK-USB**. For higher-volume programming applications, an optional programming cradle is available under part number **PROG-CRADLE**.

Programming is done by using the ERP LED Driver Configuration Tool (also known as ERP GUI), downloadable through the ERP website (<https://www.erp-power.com/erp-light-engines/led-light-programming-software/>), which enables the user to adjust output current and dimming profile.

Please note that, for each model, the **default output current setting is listed on page 2 of this datasheet.**

Furthermore, when connecting the driver to a computer using the programming cable, you can access the driver's internal data log and read the following information: SKU, serial number, manufacturing lot code, hours of operation, firmware revision, and power cycles.

While Lot programming the drivers, the ERP GUI can interface with a label printer, which enables the user to add configuration labels to driver labels in order to highlight programmed output current. Listed below is the equipment needed to print labels.

Equipment	Part Number	Where to buy
Printer	TSC TC210	<a href="http://barcodefactory.com/tsc/printers/tc210/99-059a001-54lf">barcodefactory.com/tsc/printers/tc210/99-059a001-54lf</a>
Ribbon	TSC Prem. Resin, 60mm x 110mm	<a href="http://barcodefactory.com/tsc/35-r060110-23cf">barcodefactory.com/tsc/35-r060110-23cf</a>
Labels	BAR-.81x.28-1-TT	<a href="http://barcodefactory.com/barcodefactory/labels/bar-.81x.28-1-tt">barcodefactory.com/barcodefactory/labels/bar-.81x.28-1-tt</a>

For more information, please refer to the ERP LED Driver Configuration Tool user's manual at: (<https://www.erp-power.com/erp-light-engines/led-light-programming-software/>).

**Important:** Upon initial power-up, the LED driver performs an automatic calibration and synchronization routine to detect the connected LED load. This process ensures that multiple drivers within a single luminaire or across adjacent luminaires operate in a coordinated manner, eliminating the “popcorning” effect associated with asynchronous start-up.

The calibration typically completes within 5 to 10 seconds and is automatically repeated whenever the LED load ( $V_f$ ) changes or the output current is reprogrammed. During these events, a brief startup delay and an audible tone may occur; this behavior is intentional and indicates normal operation.

Once calibration is complete, subsequent power cycles will proceed without delay or audible indication, provided the LED load and output current remain unchanged.

**Programming Cradle**  
Part number: PROG-CRADLE



**Programming Cable**  
Part number: PROG-JACK-USB



Figure 7

## 85 & 95 W Programmable Constant Current Class 2 LED Driver with 0-10 V Dimming, Dim-to-Off and Optional Auxiliary Output

### 17 - PREDICTED LIFETIME VERSUS CASE AND AMBIENT TEMPERATURE

Lifetime is defined by the measurement of the temperatures of all the electrolytic capacitors whose failure would affect light output under the nominal LED load and worst-case AC line voltage. The graphs in figures 8 and 9 are determined by the electrolytic capacitor with the shortest lifetime, among all electrolytic capacitors. It represents a worst-case scenario in which the LED driver is powered 24 hours/day, 7 days/week with no baseplate. The lifetime of an electrolytic capacitor is measured when any of the following changes in performance are observed:

- 1) Capacitance changes more than 20% of initial value
- 2) Dissipation Factor ( $\tan \delta$ ): 150% or less of initial specified value
- 3) Equivalent Series Resistance (ESR): 150% or less of initial specified value
- 4) Leakage current: less of initial specified value

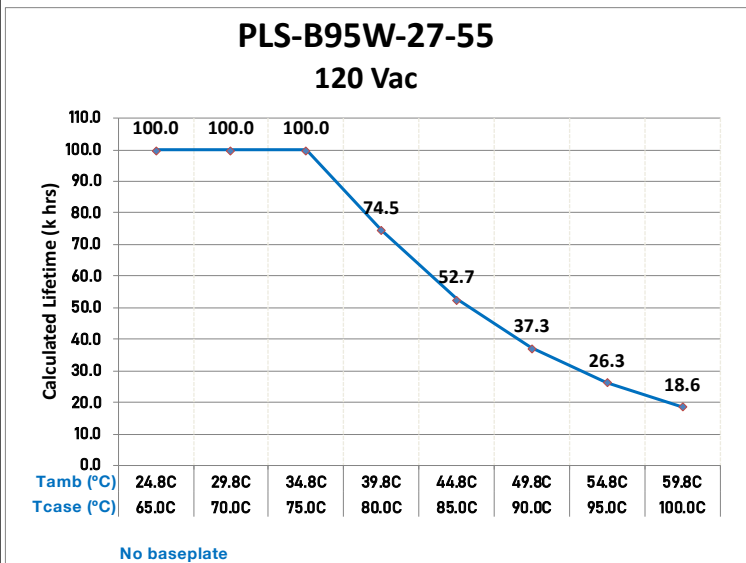

Figure 8

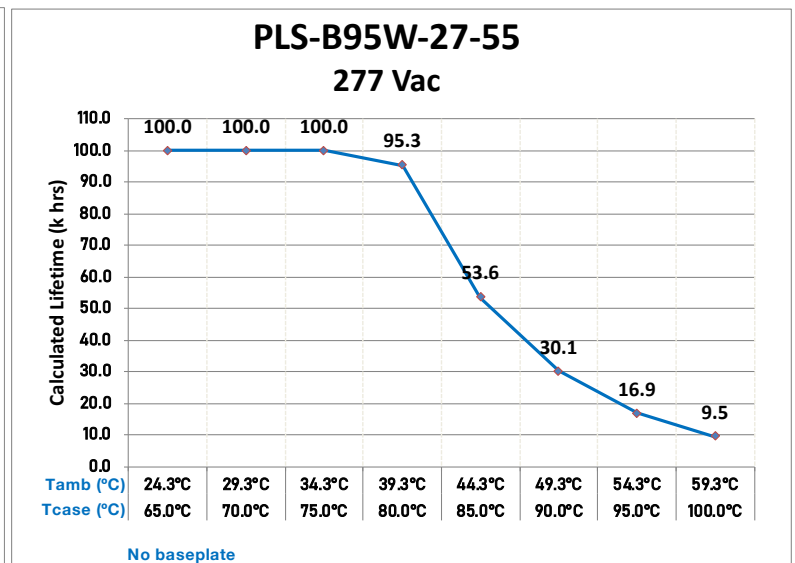

Figure 9

- NOTES:**
- The ambient temperature ( $T_{ambient}$ ) and the temperature differential between  $T_{ambient}$  and  $T_{case}$  (case temperature) shown in the graphs above are only applicable when both the LED driver and the luminaire are operating within the same ambient environment. If the LED driver is enclosed or insulated, the ambient room temperature no longer represents the actual operating conditions. In such cases, the ambient temperature should be defined as the air temperature immediately surrounding the LED driver, and thermal performance should be evaluated based solely on the case temperature ( $T_{case}$ ).
  - It should be noted the graph “Lifetime vs. Ambient Temperature” may have an error induced in the final application if the mounting has restricted convection flow around the case. For applications where this is evident, the actual case temperature measured at the Tc point in the application should be used for reliability calculations.
  - Users must utilize proper thermal management techniques to ensure proper thermal conductivity between the driver and heat sink. The use of double-sided tape to mount the driver voids the warranty.

**85 & 95 W Programmable Constant Current Class 2 LED Driver with 0-10 V Dimming, Dim-to-Off and Optional Auxiliary Output**

■ 18 – EFFICIENCY VERSUS OUTPUT VOLTAGE (100% OF OUTPUT CURRENT)

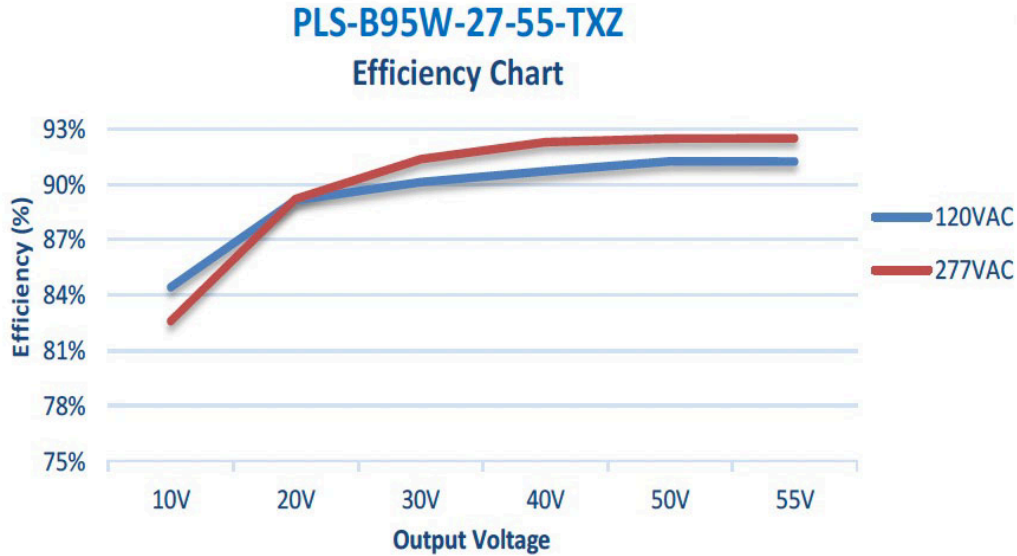

Figure 10

■ 19 – POWER FACTOR VERSUS OUTPUT VOLTAGE (100% OF OUTPUT CURRENT)

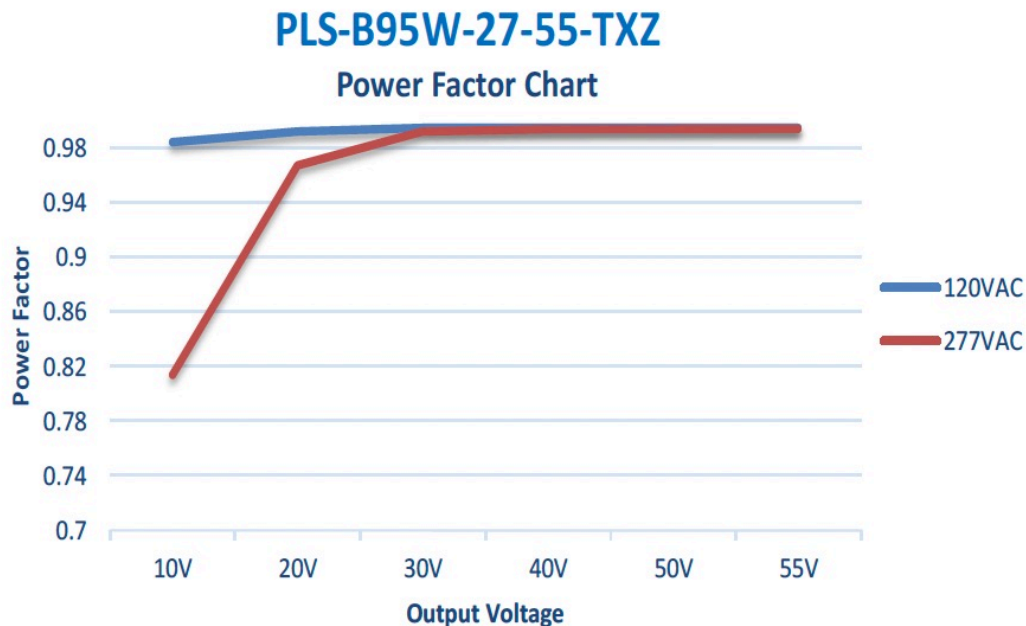
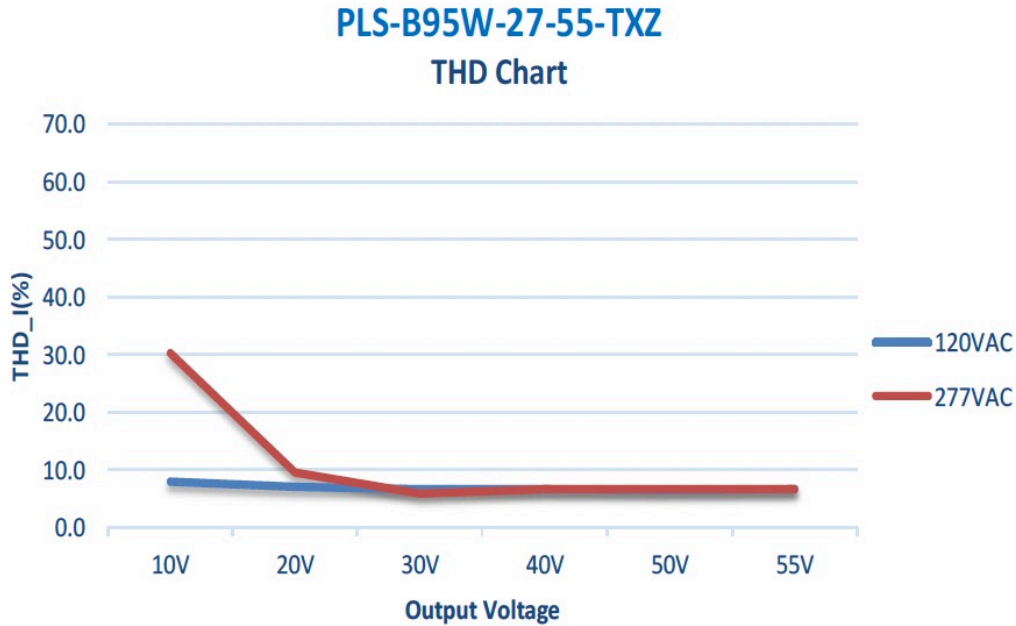

Figure 11

**NOTE: Please refer to the operating limits for power factor and THD on Figure 1 and 2 at page 3.**

**85 & 95 W Programmable Constant Current Class 2 LED Driver with 0-10 V Dimming, Dim-to-Off and Optional Auxiliary Output**

■ 20 – THD VERSUS OUTPUT VOLTAGE (100% OF OUTPUT CURRENT)



**Figure 12**

**NOTE:** Please refer to the operating limits for power factor and THD on Figure 1 and 2 at page 3.

## 85 & 95 W Programmable Constant Current Class 2 LED Driver with 0-10 V Dimming, Dim-to-Off and Optional Auxiliary Output

### 21 - MECHANICAL DETAILS “-TZ” MODELS

- **Dimensions:** L 257 x W 29.4 x H 25.4 mm (L 10.1 x W 1.2 x H 1.0 in.)
- **Volume:** 190 cm<sup>3</sup> (11.6 in<sup>3</sup>)
- **Packaging:** Aluminum case
- **I/O Connections:** Terminal Blocks
- **Ingress Protection:** IP20 rated
- **Mounting Instructions:** The PLS-B driver case must be secured on a flat surface through the two mounting tabs, shown here below in the case outline drawings. The use of double-sided tape voids the warranty.

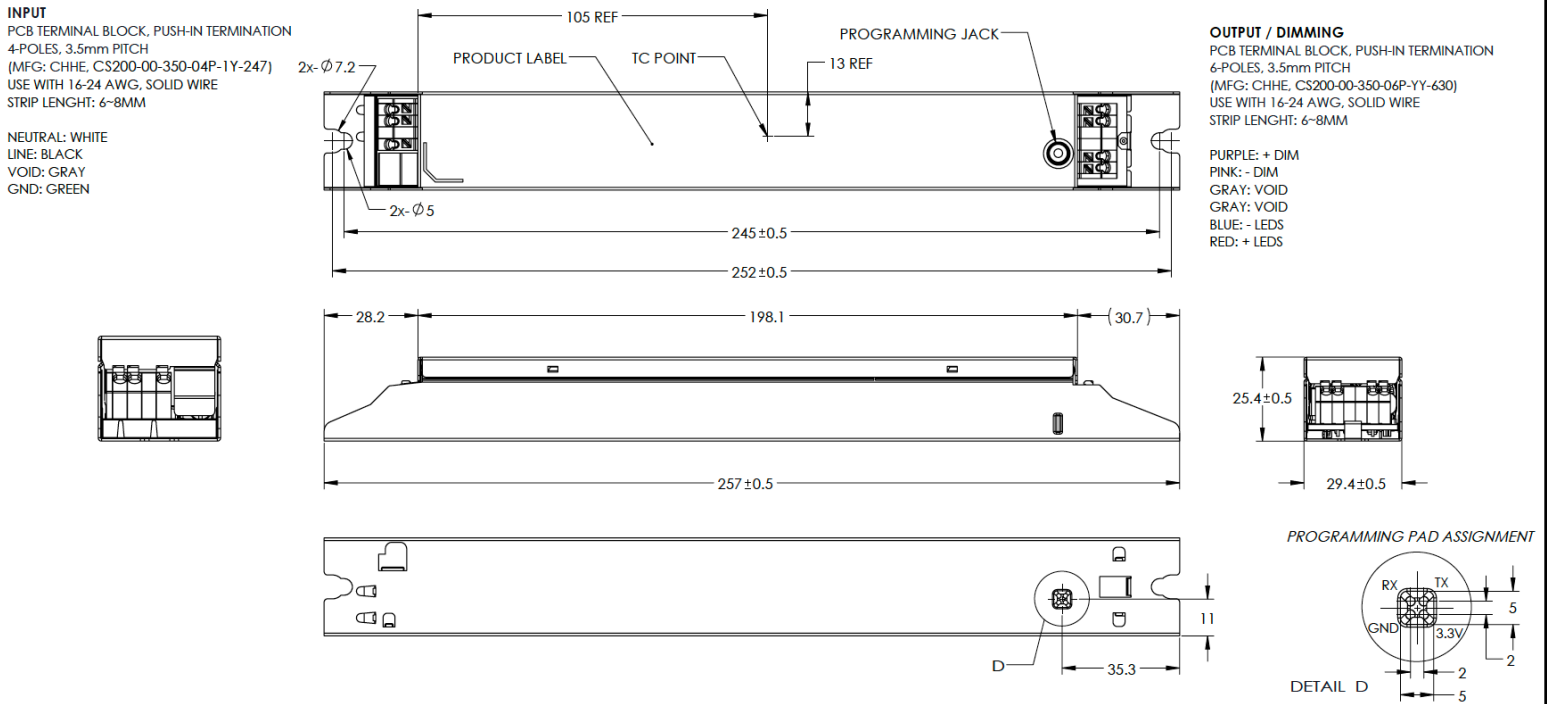

All dimensions are in mm

**Figure 13**

## 85 & 95 W Programmable Constant Current Class 2 LED Driver with 0-10 V Dimming, Dim-to-Off and Optional Auxiliary Output

### 22 - MECHANICAL DETAILS “-TXZ” MODELS

- **Dimensions:** L 257 x W 29.4 x H 25.4 mm (L 10.1 x W 1.2 x H 1.0 in.)
- **Volume:** 190 cm<sup>3</sup> (11.6 in<sup>3</sup>)
- **Packaging:** Aluminum case
- **I/O Connections:** Terminal Blocks
- **Ingress Protection:** IP20 rated
- **Mounting Instructions:** The PLS-B driver case must be secured on a flat surface through the two mounting tabs, shown here below in the case outline drawings. The use of double-sided tape voids the warranty.

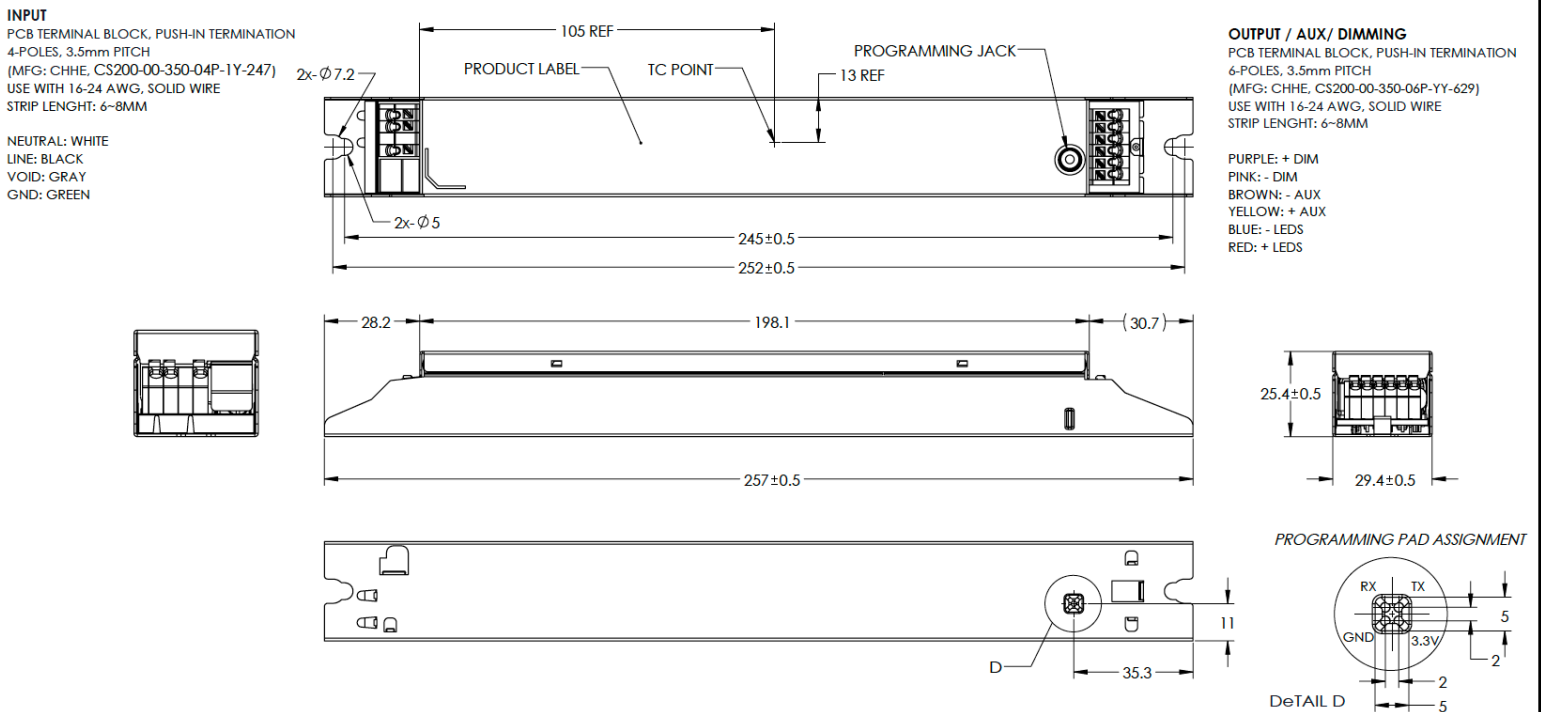

All dimensions are in mm

**Figure 14**

## 85 & 95 W Programmable Constant Current Class 2 LED Driver with 0-10 V Dimming, Dim-to-Off and Optional Auxiliary Output

### 23 - LABELING

The PLS-B95W-27-55-TXZ is used in figure 15 as an example to illustrate a typical label.

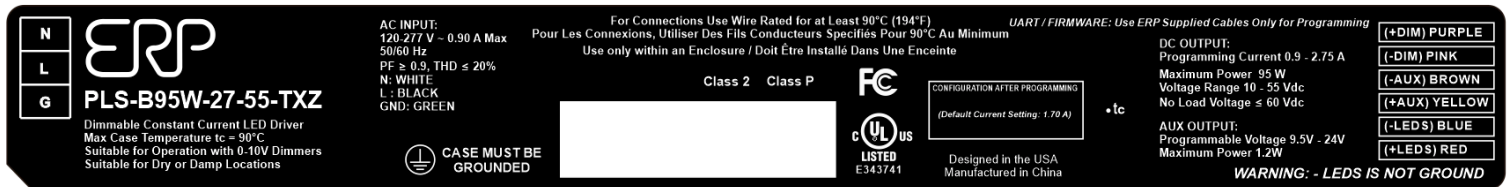

Figure 15

The PLS-B95W-27-55-TZ is used in figure 16 as an example to illustrate a typical label.

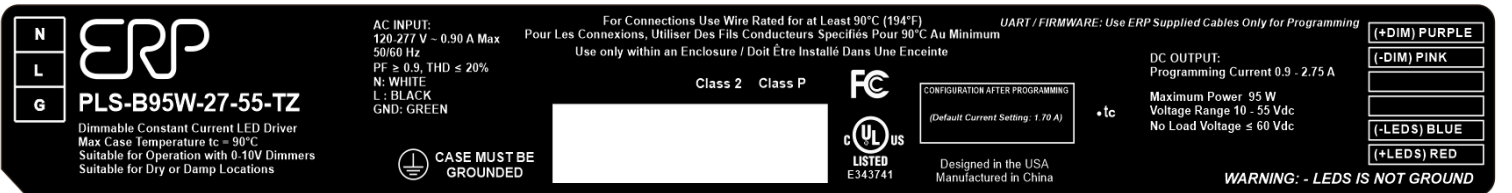

Figure 16

**USA Headquarters**  
Tel: +1-805-517-1300  
Fax: +1-805-517-1411  
2625 Townsgate Road, Suite 106  
Westlake Village, CA 91361, USA

**CHINA Operations**  
Tel: +86-756-6266298  
Fax: +86-756-6266299  
No. 8 Pingdong Road 2  
Zhuhai, Guangdong, China 519060

ERP Power, LLC (ERP) reserves the right to make changes without further notice to any products herein. ERP makes no warranty, representation or guarantee regarding the suitability of its products for any particular purpose, nor does ERP assume any liability arising out of the application or use of any product or circuit, and specifically disclaims any and all liability, including without limitation special, consequential or incidental damages. "Typical" parameters which may be provided in ERP data sheets and/or specifications can and do vary in different applications and actual performance may vary over time. All operating parameters, including "Typicals" must be validated for each customer application by customer's technical experts. ERP does not convey any license under its patent rights nor the rights of others. ERP products are not designed, intended, or authorized for use as components in systems intended for surgical implant into the body, or other applications intended to support or sustain life, or for any other application in which the failure of the ERP product could create a situation where personal injury or death may occur. Should Buyer purchase or use ERP products for any such unintended or unauthorized application, Buyer shall indemnify and hold ERP and its officers, employees, subsidiaries, affiliates, and distributors harmless against all claims, costs, damages, and expenses, and reasonable attorney fees arising out of, directly or indirectly, any claim of personal injury or death associated with such unintended or unauthorized use, even if such claim alleges that ERP was negligent regarding the design or manufacture of the part. ERP is an Equal Opportunity/Affirmative Action Employer. This literature is subject to all applicable copyright laws and is not for resale in any manner.

## 85 & 95 W Programmable Constant Current Class 2 LED Driver with 0-10 V Dimming, Dim-to-Off and Optional Auxiliary Output

### Revision History

Date	Comments
02OCT2024	<ul style="list-style-type: none"> <li>• Preliminary Release</li> </ul>
08OCT2024	<ul style="list-style-type: none"> <li>• Added 6 kV as surge standard</li> <li>• Changed color of Aux- to Gray</li> <li>• Added Aux output spec</li> </ul>
09OCT2024	<ul style="list-style-type: none"> <li>• Removed 85 W</li> <li>• Changed Aux- to Brown</li> <li>• Decreased max efficiency to 86%</li> </ul>
28JUL2025	<ul style="list-style-type: none"> <li>• Added 85 W model. Same case from 20 W up to 85 W</li> </ul>
29JUL2025	<ul style="list-style-type: none"> <li>• Updated the auxiliary output section</li> </ul>
04AUG2025	<ul style="list-style-type: none"> <li>• Added 2 PLS-95B models</li> <li>• Engineering spec of record: 0010-03996 rev.X01</li> </ul>
29AUG2025	<ul style="list-style-type: none"> <li>• Only kept the PLS-B85W and PLS-B95W</li> </ul>
04SEP2025	<ul style="list-style-type: none"> <li>• Added notes 1 &amp; 2 to the ORDERING INFORMATION section</li> </ul>
28OCT2025	<ul style="list-style-type: none"> <li>• Added label in section 20</li> </ul>
11DEC2025	<ul style="list-style-type: none"> <li>• Added note at the bottom of Section 14 “Programming”</li> <li>• Updated synchronization time to 100 ms</li> <li>• Added 0-10V Dimming Circuit Protection</li> </ul>
21JAN2026	<ul style="list-style-type: none"> <li>• Added ANSI C137.1 compliance on front page</li> <li>• Change the output voltage regulation on the auxiliary output to +/-20%</li> <li>• Removed the parameter IEC61000-3-2 in section which does not apply to North America</li> <li>• Added MCO for the PLS-B-TXZ with auxiliary output</li> <li>• Rewrote section 6 (Default 0-10V Dimming Profile) and section 12 (0-10V Dimming)</li> <li>• Included a new section 15 (compatibility with external sensors)</li> </ul>
27JAN2026	<ul style="list-style-type: none"> <li>• Updated section 14 (connection and compatibility with external sensors)</li> </ul>
02APR2026	<ul style="list-style-type: none"> <li>• Updated lifetime graphs and Lifetime: 5 years @ Tc ≤ 85°C</li> </ul>
28APR2026	<ul style="list-style-type: none"> <li>• Updated labels</li> <li>• Added specification for standby power in Section 4 (Input Specification)</li> </ul>